

CONVEYOR

Increase Productivity and Reduce Downtime

Quality Conveyor Solutions

Our quality custom-made conveyor products are designed to maximise performance whilst minimising ongoing maintenance requirements, delivering the lowest cost of ownership possible.

TAILORED CONVEYOR SOLUTIONS

CR's conveyor solutions are designed and manufactured locally. With over 40 years of experience, our extensive range includes conveyor components and accessories for a variety of conveyor belt applications.

LOADZONE

Transfer point products that reduce spillage and prolong belt life

IB Impact Beds

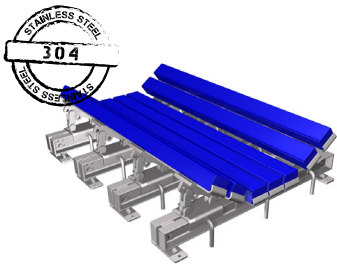
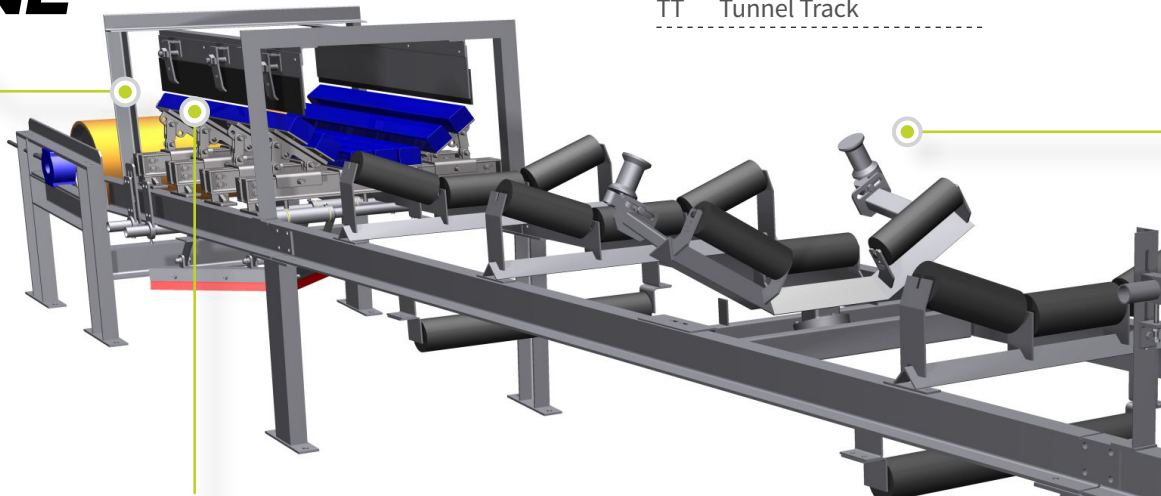

SKIRT

Dust and product containment solutions for conveyor transfer points

SC Sure Clamp

SCM Sure Clamp Mini

SU Sure Seal

SF Sure Fit



TRACK

Custom built for optimal belt tracker performance

1RF 1 Roll Flat

2RV 2 Roll V

3RT 3 Roll Trough

TT Tunnel Track



What makes our products unique:

- In-house design, engineering and technical support
- Stainless Steel Grade 304 as standard for belt cleaning systems
- Supporting capital projects through to operational spare parts
- Delivering lower maintenance cost, improved service life and longevity of wear parts

SPRAY

Water application and control systems for high performance belt cleaning

SB Spray Bars

WCM Water Control Manifolds



CLEAN

Efficient, low maintenance belt cleaning systems

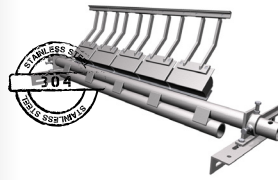
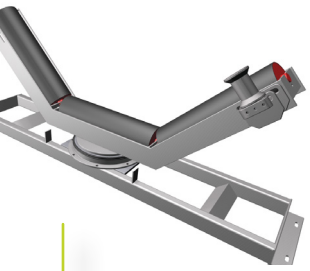

PRIMARY

- HT Tungsten Tips
- HU Urethane Tips

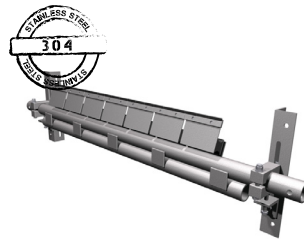

SECONDARY

- | | | | |
|------------------|-----------------------------------|----------------|-----------------------------------|
| SINGLE DIRECTION | | BI-DIRECTIONAL | |
| PT | Tungsten Tips | RT | Tungsten Tips |
| PT-S | Tungsten Tips & Integrated Sprays | RT-S | Tungsten Tips & Integrated Sprays |
| UT | Tungsten | BP | Polymer Bristle |
| UU | Urethane | | |

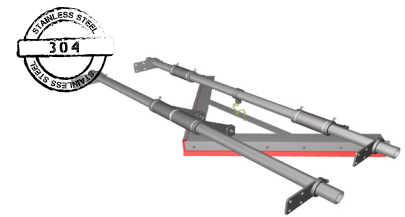
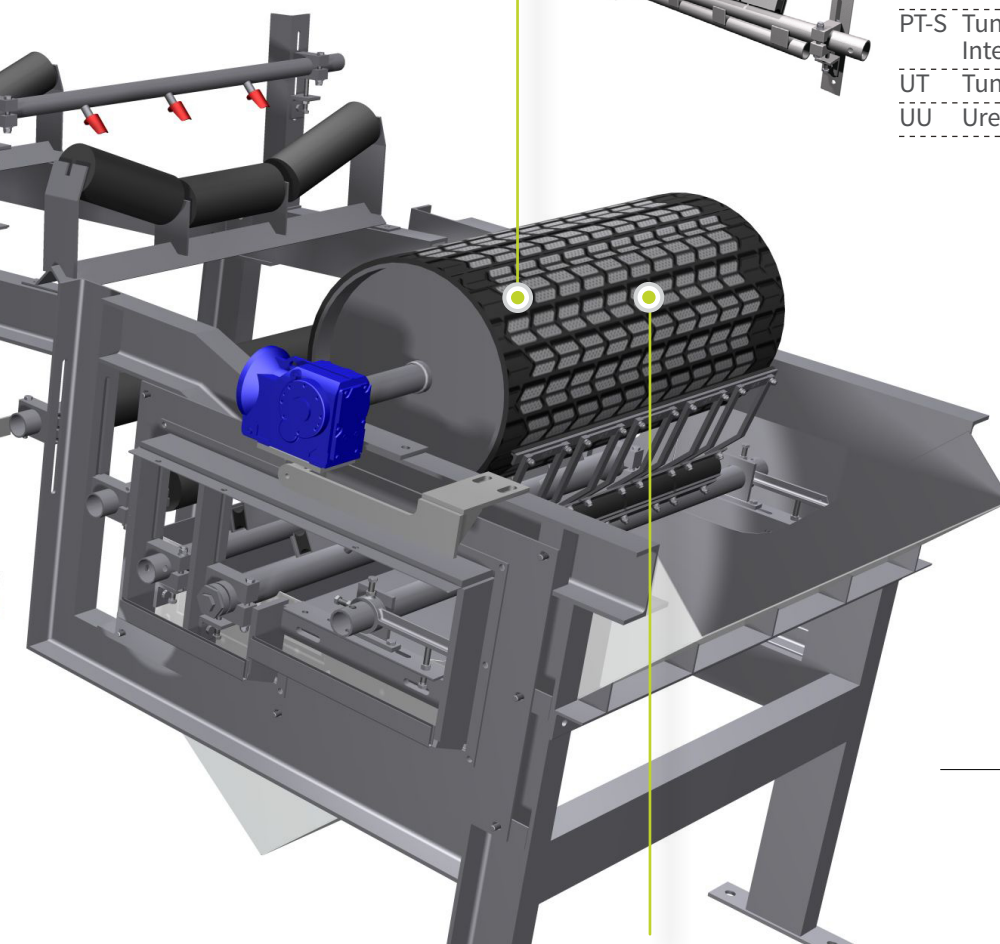

PLOUGHS

- V Plough
- VF Failsafe
- VFH Failsafe Heavy Duty
- D Diagonal
- DR Diagonal Reversing

LAG

Comprehensive range of high quality pulley lagging solutions

- RL Rubber
- RC Ceramic
- SP Strip Polyurethane
- HCP Hot Cast Polyurethane

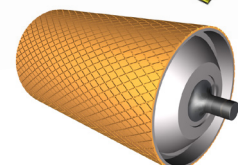
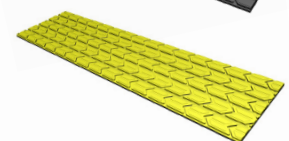

TAILORED CONVEYOR SOLUTION

Down-to-Earth Service and Support

Our complete range of conveyor accessories is supported by prompt delivery and a high standard of service and support.

We undertake regular product review and continuous improvement based on customer feedback. We identify appropriate cost effective conveyor solutions to meet our client's specific needs.

Technical Expertise and Advice

We have the product range and in-house technical support, to supply products for all conveyor applications.

From mining, milling and smelting, to bulk materials handling and more, CR's conveyor division meets the needs of multiple industries.

We design and manufacture a range of block and wear products, stone dusting systems, conveyor accessories and fabrications for specific projects and applications.

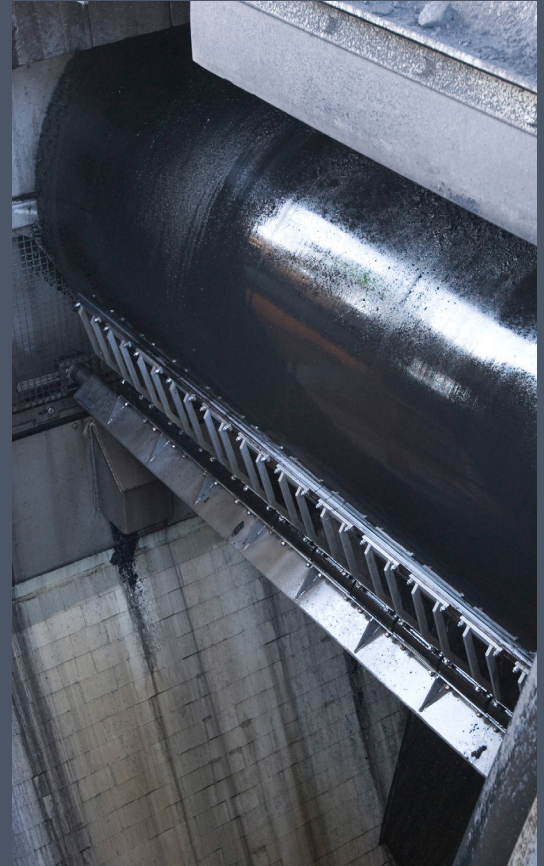

Our team offers:

- Extensive range of stock conveyor products
- In-house technical experts to discuss conveyor reliability and performance issues
- Comprehensive range of supportive product
- Documentation and manuals
- Product training support for field operatives
- Complete packages including design and layout for new and existing conveyor projects
- Complete wear packages including design and layouts for fixed plant and mobile equipment applications

CR Mining is on a mission to revolutionise mining productivity.

We engineer the most advanced surface and underground mining solutions for the world's best miners to unlock productivity, enhance safety, and reduce maintenance requirements.

Start the conversation



(+61) 1800 987 525



GlobalSales@CRmining.com



(+1) 866 276 4637



CRmining.com